

ONLINE INSTRUCTIONS

27 mm Midrange CB Traveler Cars



WARNING! Strictly follow all instructions to avoid an accident, damage to your vessel, personal injury, or death. See www.harken.com/manuals for additional safety information.

IMPORTANT! See Inspection and Maintenance at end of manual.

Features

One-piece car body: Machined from 6061-T6 aluminum for strength and durability.

Hard Lube-anodized: PTFE coated for durability.

Captive ball bearings: Cars easy to load and maintain.

Free running ball bearings in car and control blocks: Easy to adjust car under load.

Newer style CB+ cars: Can convert to old-style non-CB track.

Terms

CB – Captive bearings. Wire retaining clips hold bearings captive for easy loading onto track and for maintenance.

CB+ cars – CB cars that can convert to old-style, non-CB track.

Corner keepers – Used on CB+ cars to help retain balls when cars are off track. Introduced beginning of 2015.

Retaining clips – Formed wires for holding bearings.

CB style track – Track designed with deeper grooves to accept CB car retaining clips.

CB+ Car Underside

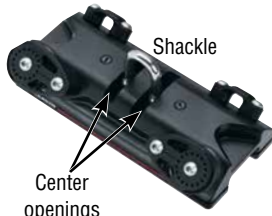
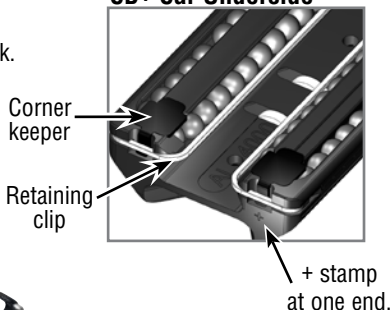

Dimensions

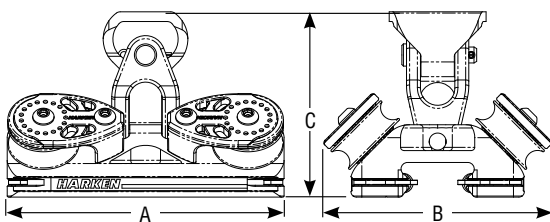

| Part No. | Description | A | | B | | C | | Maximum working load | | Breaking load | |
|-----------|--|------|-----|------|----|-----|----|----------------------|------|---------------|------|
| | | in | mm | in | mm | in | mm | lb | kg | lb | kg |
| T2701B | Car/shackle | 4/4 | 108 | 2/4 | 70 | 2 | 50 | 1800 | 816 | 5000 | 2268 |
| T2701B.HL | High-load car/shackle | 5/16 | 132 | 2/4 | 70 | 2 | 50 | 2300 | 1043 | 5000 | 2268 |
| T2702B | Car/stand-up toggle | 4/4 | 108 | 2/4 | 70 | 3/8 | 80 | 1800 | 816 | 5000 | 2268 |
| T2702B.HL | High-load car/stand-up toggle | 5/16 | 132 | 2/4 | 70 | 3/8 | 80 | 2300 | 1043 | 5000 | 2268 |
| T2703B | Car/stand-up toggle/ears | 4/4 | 108 | 2/4 | 70 | 3/8 | 80 | 1800 | 816 | 5000 | 2268 |
| T2703B.HL | High-load car/stand-up toggle/ears | 5/16 | 132 | 2/4 | 70 | 3/8 | 80 | 2300 | 1043 | 5000 | 2268 |
| T2704B.HL | 2 cars/2 stand-up toggles | 8/4 | 222 | 2/4 | 70 | 3/8 | 80 | 3600 | 1632 | 7200 | 3266 |
| T2705B | Car/soft attachment | 4/4 | 108 | 2/4 | 70 | 1/2 | 38 | 1800 | 816 | 5000 | 2268 |
| T2705B.HL | High-load car/soft attachment | 5/16 | 132 | 2/4 | 70 | 1/2 | 38 | 2300 | 1043 | 5000 | 2268 |
| T2721B | Car/shackle/2:1 controls | 4/4 | 108 | 3 | 76 | 2 | 50 | 1800 | 816 | 5000 | 2268 |
| T2721B.HL | High-load car/shackle/2:1 controls | 5/16 | 132 | 3 | 76 | 2 | 50 | 2300 | 1043 | 5000 | 2268 |
| T2722B | Car/stand-up toggle/2:1 controls | 4/4 | 108 | 2/4 | 70 | 3/8 | 80 | 1800 | 816 | 5000 | 2268 |
| T2722B.HL | High-load car/stand-up toggle/2:1 controls | 5/16 | 132 | 2/4 | 70 | 3/8 | 80 | 2300 | 1043 | 5000 | 2268 |
| T2731B | Car/shackle/3:1 controls | 4/4 | 108 | 3/32 | 81 | 2 | 50 | 1800 | 816 | 5000 | 2268 |
| T2731B.HL | High-load car/shackle/3:1 controls | 5/16 | 132 | 3/32 | 81 | 2 | 50 | 2300 | 1043 | 5000 | 2268 |
| T2732B | Car/stand-up toggle/3:1 controls | 4/4 | 108 | 3/4 | 82 | 3/8 | 80 | 1800 | 816 | 5000 | 2268 |
| T2732B.HL | High-load car/stand-up toggle/3:1 controls | 5/16 | 132 | 3/4 | 82 | 3/8 | 80 | 2300 | 1043 | 5000 | 2268 |
| T2741B | Car/shackle/4:1 controls | 4/4 | 108 | 3/8 | 86 | 2 | 50 | 1800 | 816 | 5000 | 2268 |
| T2741B.HL | High-load car/shackle/4:1 controls | 5/16 | 132 | 3/8 | 86 | 2 | 50 | 2300 | 1043 | 5000 | 2268 |
| T2742B | Car/stand-up toggle/4:1 controls | 4/4 | 108 | 3/8 | 86 | 3/8 | 80 | 1800 | 816 | 5000 | 2268 |
| T2742B.HL | High-load car/stand-up toggle/4:1 controls | 5/16 | 132 | 3/8 | 86 | 3/8 | 80 | 2300 | 1043 | 5000 | 2268 |
| T2744B.HL | 2 cars/2 stand-up toggles/4:1 controls | 8/4 | 222 | 2/4 | 70 | 3/8 | 80 | 3600 | 1632 | 7200 | 3266 |

Track Compatibility

CB cars are shipped for use on CB track with grooves at waist to accept retaining clips first supplied by Harken in 2002. See end of manual if you have older track.

CB Track

| Part No. | A | | B | | C | |
|--|--------------------------------|----|--------------------------------|----|--------------------------------|----|
| | in | mm | in | mm | in | mm |
| Low-profile track | | | | | | |
| 1602.6, 1602.8, 1602.12, R27.1, R27.1.2, R27.1.5M, R27.1.8, R27.2.M, R27.2.5M, R27.3M, R27.3.6M, R27.6M | 1 ¹ / ₁₆ | 27 | 9 ⁹ / ₁₆ | 14 | 1 | 25 |
| High-beam track | | | | | | |
| R27HB.1, R27HB.1.5M, R27HB.1.8M, R27HB.2.5M, R27HB.3.6M | 1 ¹ / ₁₆ | 27 | 1 ⁵ / ₈ | 42 | 1 ¹ / ₃₂ | 31 |

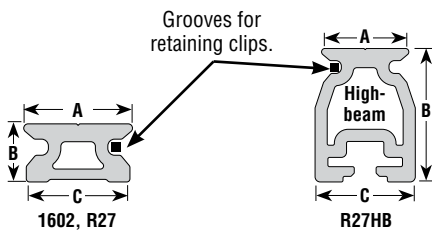

Curved Track Limitations

Cars will not roll on curved track if the radius is under the minimum listed below. A shorter car can roll on a smaller radius. Refer to the chart below and make sure the radius is equal to, or greater than the radius listed for the car. To find the radius go to www.harken.com.

| Car | Minimum radius | |
|---|----------------|------|
| | ft | m |
| 1624, 1626, 1628, 1635, T2701B, T2702B, T2703B, T2721B, T2731B, T2741B, T2705B | 8 | 2.44 |
| 1625, 1627, 1629, 1636, T2701B.HL, T2702B.HL, T2703B.HL, T2721B.HL, T2731B.HL, T2741B.HL, T2705B.HL | 9 | 2.73 |

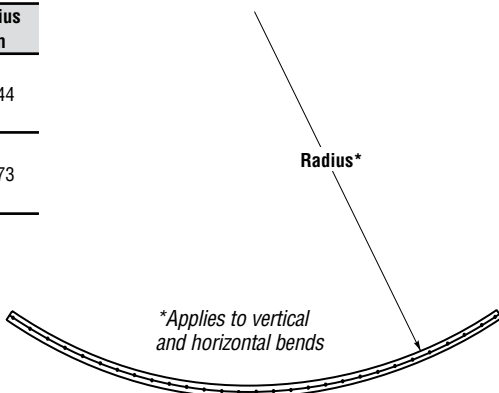

Track for Unsupported Spans

R27 mm High-beam track spanning chart

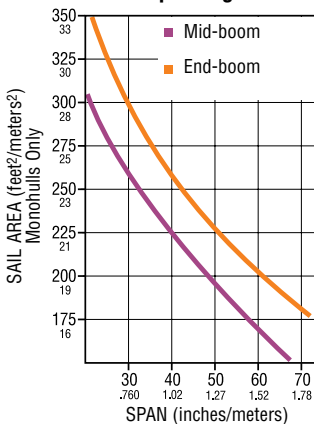

Harken high-beam track is designed for unsupported spans. The length of span depends on the load on the car. The higher the car load, the less span the track can handle. If the car is sized correctly, car length determines the spanning capability. Longer, high-load (HL) cars require shorter spans because the loads are so much greater. See track-spanning chart in track instructions or at www.harken.com.



Attaching Mainsheet and Control Blocks



Stand-up toggle

Stand-up toggles – Harken stand-up toggles fit specific Harken blocks. To determine mainsheet block compatibility, see 4501 instructions online: www.harken.com/manuals

Soft attachment (T2705B, T2705B.HL) – To attach loops or straps, remove stop screws and push attachment post out. Assemble post using blue Loctite® adhesive on screws.

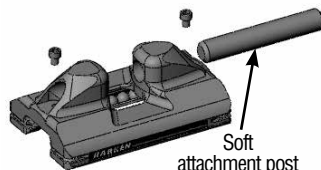

Soft attachment post

Loctite is a registered trademark of Henkel AG & Company KGaA.

Installing CB Traveler Car on Track

Position car at end of track and gently roll on. Car should roll on easily. If not, check to make sure you are using CB track. **Do not remove ball retaining clips.** Cars will not roll unless they have retaining clips. **Exception: CB+ cars can convert to non-CB cars. See end of manual.**

Attaching Splice to Deadend on Car or Controls

To attach premade splice, pass eye through bail and run tail through to make a hitch without undoing bail. If line is too large for this, remove one screw and rotate deadend eyestraps to load the splice. Reassemble screws using thread-locking solution such as blue Loctite® adhesive.

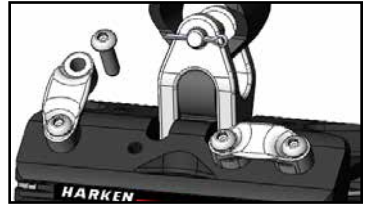

Reeving Cars and End Control Blocks

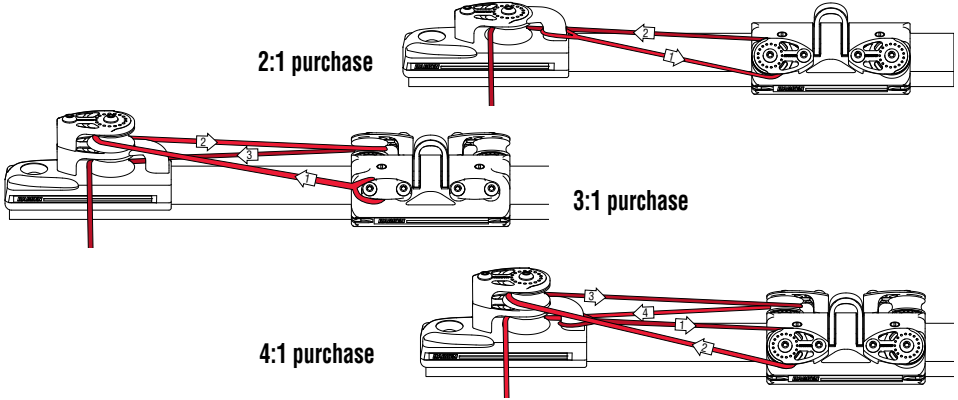

Reeving Cars and Ball Bearing End Control Blocks

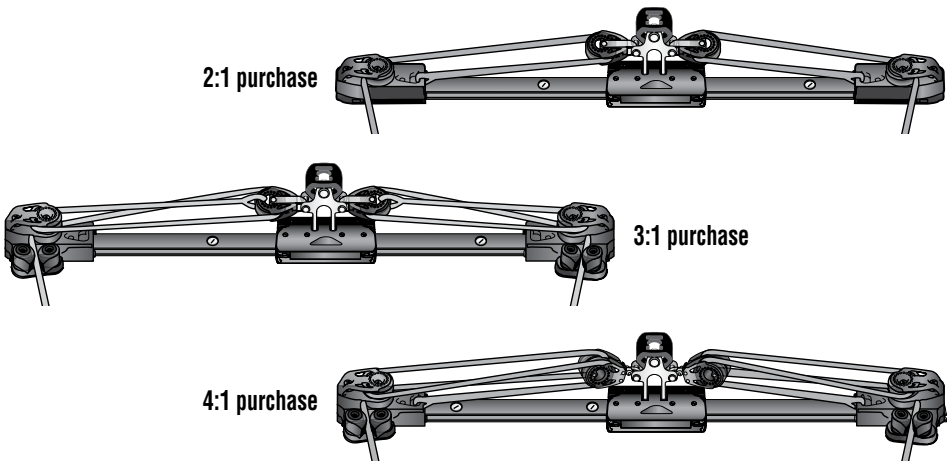

Loading Ball Bearings into CB Cars

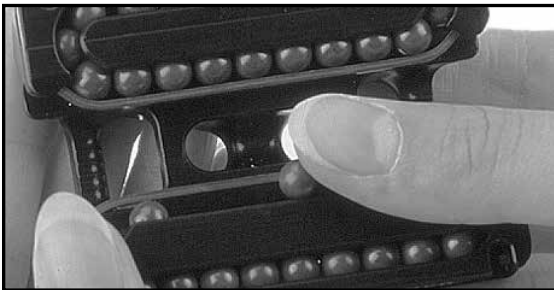

Position car on edge with retaining clip in place. Gently push one (1) ball at a time into car from center of clip. Allow balls to roll into return race and insert remaining balls. **Do not overfill car!**

Ball Replacement Chart

| Car | Length | Balls/car | Balls | Order | Balls/set | Ball Ø |
|--|------------------|-----------|---------|-------|-----------|--------------|
| T2701B, T2702B, T2703B, T2705B, T2721B, T2722 B, T2731B, T2732B, T2741B, T2742B | 4 1/4" (108 mm) | 48 | Torlon® | 1526 | 25 | 5/16" (8 mm) |
| T2701B.HL, T2702B.HL, T2703B.HL, T2705B.HL, T2721B.HL, T2722B.HL, T2731B.HL, T2732B.HL, T2741B.HL, T2742B.HL | 5 5/16" (132 mm) | 60 | Torlon | 1526 | 25 | 5/16" (8 mm) |
| T2704B.HL, T2744B.HL (coupled car assemblies) | 8 3/4" (222 mm) | 48 x 2* | Torlon | 1526 | 25 | 5/16" (8 mm) |

*Coupled car assembly—each car has 48 balls.

Removing Ball Bearings from CB Cars

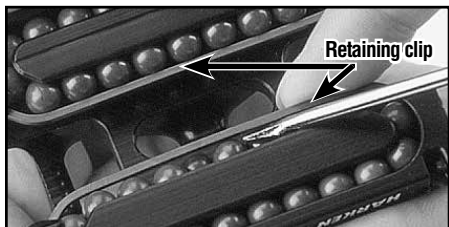

Position car on edge and gently push one (1) ball at a time from center of retaining clip. **Do not remove retaining clip from car!**

CB + Cars can Convert to Fit Old-Style, Non-CB Track

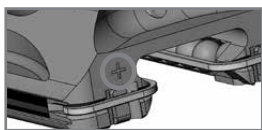

CB+ cars designed for CB track.



CB+ cars can convert to run on old-style, non-CB track.

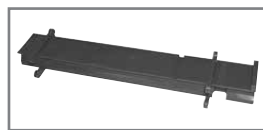

Order HMR2 car loader.

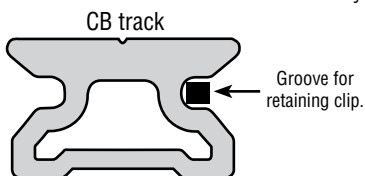

Track built after 2002. No need to convert car.

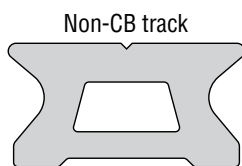

Track built before 2002.

Converting CB + Cars to Run on Non-CB Track

Important! Requires CB+ cars. See complete instructions at www.harken.com/manuals.



1. Use flat-bladed screwdriver to push retaining clip toward end.



2. Pry retaining clip off and dump balls in box.



3. Remove retaining clips and corner keepers over box to catch balls.



4. Hold car on edge and load lower side with correct number of balls. **DO NOT OVERLOAD.** Consult chart to confirm quantity.



5. Remove two (2) clips from car loader. Slide car loader in so loading port is on the side of car without balls.



6. Put one (1) clip on "open" end of loader. Load rest of balls through ball loading port into empty bearing race. Consult chart to confirm quantity. Line up car loader with track and gently roll car onto track.

Do not use corner keepers.

Inspect

Frequently inspect shackles and control block fittings for signs of fatigue. Replace as necessary. Make sure every installation includes Harken track endstops. Arrange control tackle so cars do not hit endstops under load.

Maintenance

Traveler cars: Clean by frequently flushing with fresh water. Periodically clean car by squirting a detergent/water solution into center openings. Roll car back and forth to distribute evenly. Flush bearings with fresh water.

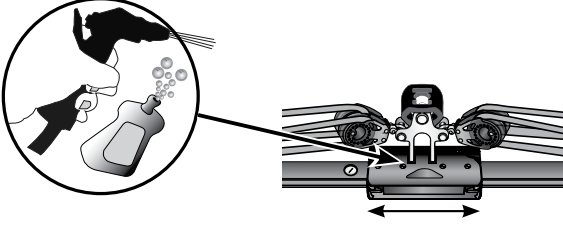

Do not use spray lubricants because ball bearings can skid, not roll. Once car and track are dry, apply one (1) to two (2) drops of McLube® OneDrop™ ball bearing conditioner to ball contact surfaces of track. Roll car back and forth through OneDrop conditioner several times to distribute onto bearings. Wipe remaining OneDrop off track. OneDrop conditioner is preferred, but you can also use one (1) to two (2) drops of a light machine oil. Too much oil attracts dirt.

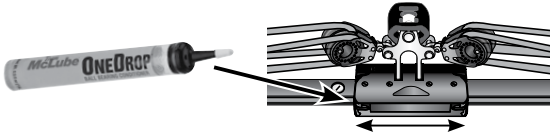

Track: Clean with detergent and water.

Important! Exposure to some teak cleaners and other caustic solutions can result in discoloration of part and is not covered under the Harken warranty.

Warranty

For additional safety, maintenance, and warranty information see www.harken.com/manuals or the Harken catalog.